

**SEWING MACHINE TABLE**  
**COMFORT 3 (C3L, C3XL)**  
**СТОЛ ДЛЯ ШВЕЙНОЙ МАШИНЫ**

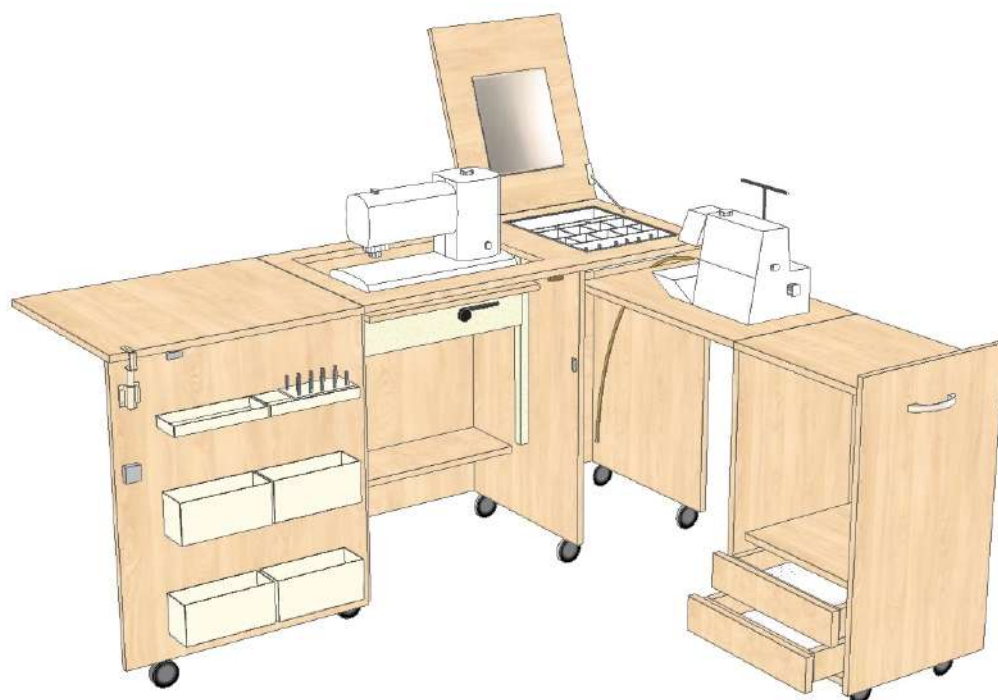

# ***SYMBOLS***



***ATTENTION***

***ВНИМАНИЕ***



***ASSEMBLY & ADJUSTMENT***

***СБОРКА РЕГУЛИРОВКА***



***OPERATION***

***ЭКСПЛУАТАЦИЯ***



***STORAGE***

***ХРАНЕНИЕ***

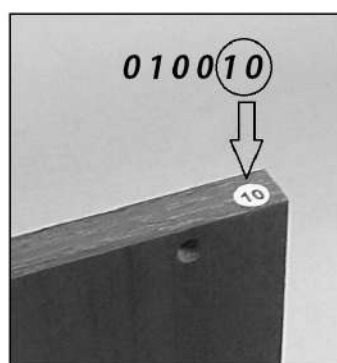

***INDICATING MARK***

***ОБОЗНАЧЕНИЕ***



***SPECIAL OPERATION***

***СПЕЦИАЛЬНЫЕ ОПЕРАЦИИ***

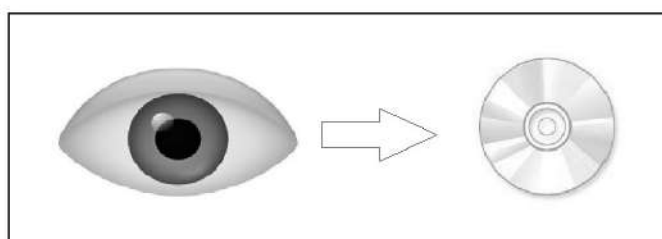

***WATCH DVD***

***СМОТРЕТЬ DVD***

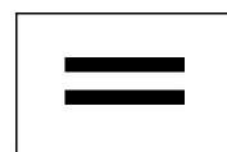

***EQUALITY***

***РАВЕНСТВО***

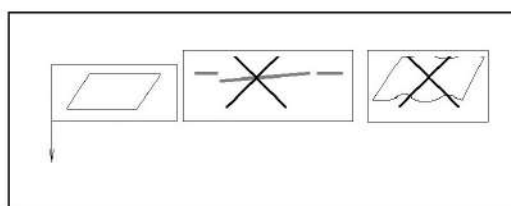





















***EVEN SURFACE***

***РОВНАЯ ПОВЕРХНОСТЬ***

010001	1 x	010002	1 x	010003	1 x
010004	1 x	010006	1 x	010007	1 x
010008	1 x	010009	1 x	010010	1 x
010011	2 x	010012	2 x	010013	2 x
010014	1 x	010023	1 x	010024	1 x
010025	1 x	010026	1 x	010027	1 x
010028	1 x	010029	1 x		

 <p>020001 4x</p>	 <p>020002 2x</p>	 <p>020003 1x</p>	 <p>020004 1x</p>	 <p>020005 1x</p>
 <p>020006 2x</p>	 <p>020008 1x</p>	 <p>020010 1x</p> <p>L 660</p>	 <p>020011 1x</p>	 <p>020012 1x</p>
 <p>1x 020007</p>		 <p>1x 020009</p> <p>L300</p>		
 <p>3x 020013 CR</p>		 <p>3x 020013 CL</p>		
 <p>3x 020015 DR</p>		 <p>3x 020015 DL</p>		
 <p>2x 020016</p>	 <p>2x 020017</p>		 <p>020021 4x</p>	

030001  3 * 16 <b>45x</b>	030002  3,5 * 16 <b>29x</b>	030003  6,2 * 50 <b>16x</b>	030004  φ 5 * 30 <b>6x</b>	030005  4,2 * 16 <b>25x</b>	030006  2,9 * 13 <b>4x</b>	030007  φ 6 <b>2x</b>	030008  φ 4 <b>4x</b>	030009  M4 * 20 <b>4x</b>	030010  φ 6 <b>4x</b>
030011  φ 15 <b>16x</b>	030012  φ 18 <b>17x</b>	030013  L 35 <b>17x</b>	030014  φ 15 h 12 <b>17x</b>	030015  φ 8 * 30 <b>18x</b>	030016  φ 8 * 30 <b>4x</b>	030017  φ 15 h 12 <b>4x</b>	030020  3,5 * 20 <b>4x</b>	030022  M 10 <b>4x</b>	030023  φ 10 <b>4x</b>

030024  5 * 50 <b>2x</b>
--

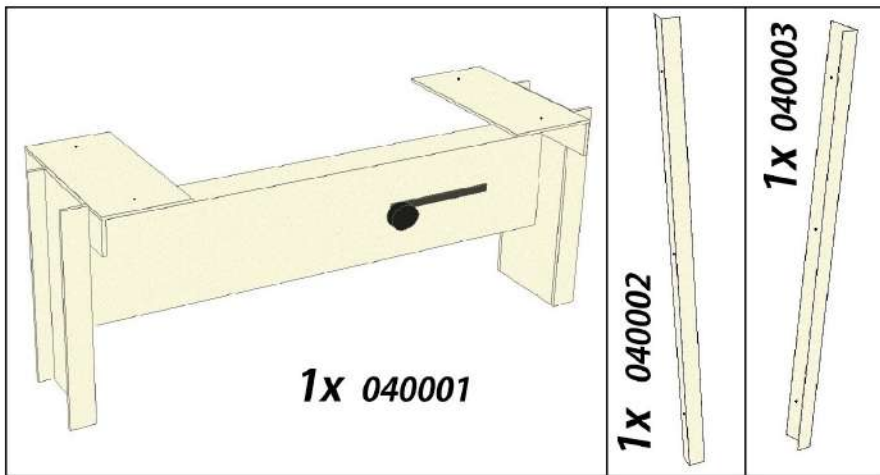



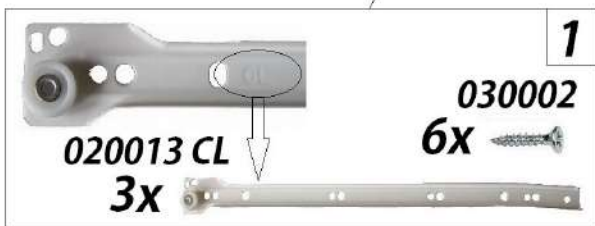
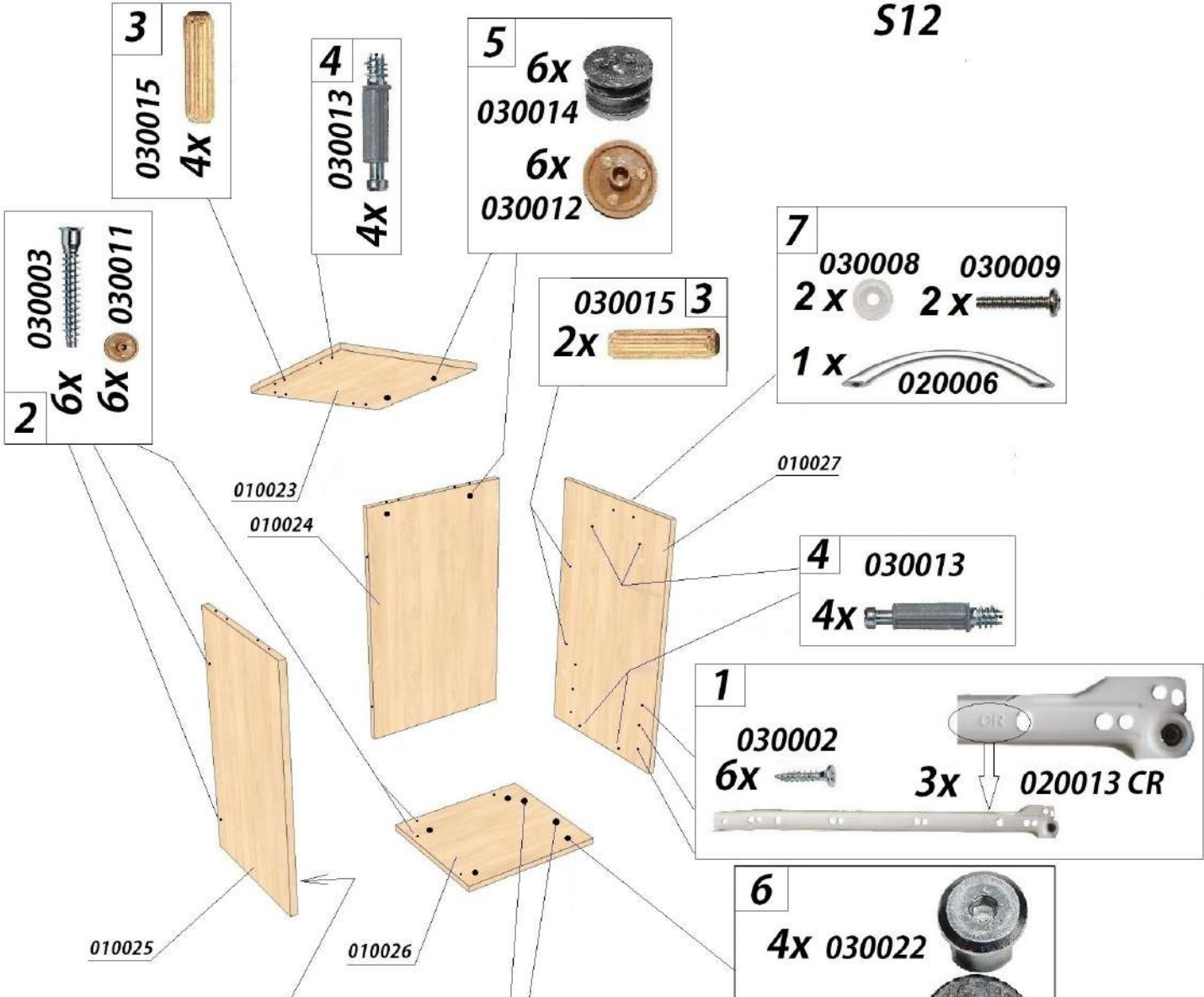

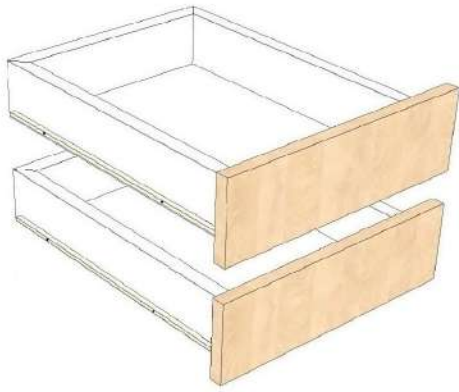

**11**

4x 030001

2x 020015 DR

030016 **9**

4x

**10**

4x 030017

2x 010012

2x 010013

**11**

2x 020015 DL

4x 030001

2x 010011

**8**

4x 030015

**14** 2x 030024

2x 020017

**12**

1x 020015 DL

2x 030001

1x 010028

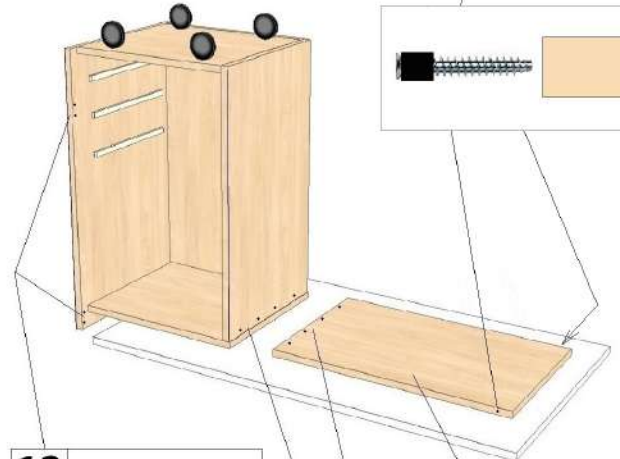
1x 010029

**12**

2x 030001

1x 020015 DR

**13**

4x 030002

2x 020016

**15** 1x 020009 10x 030001

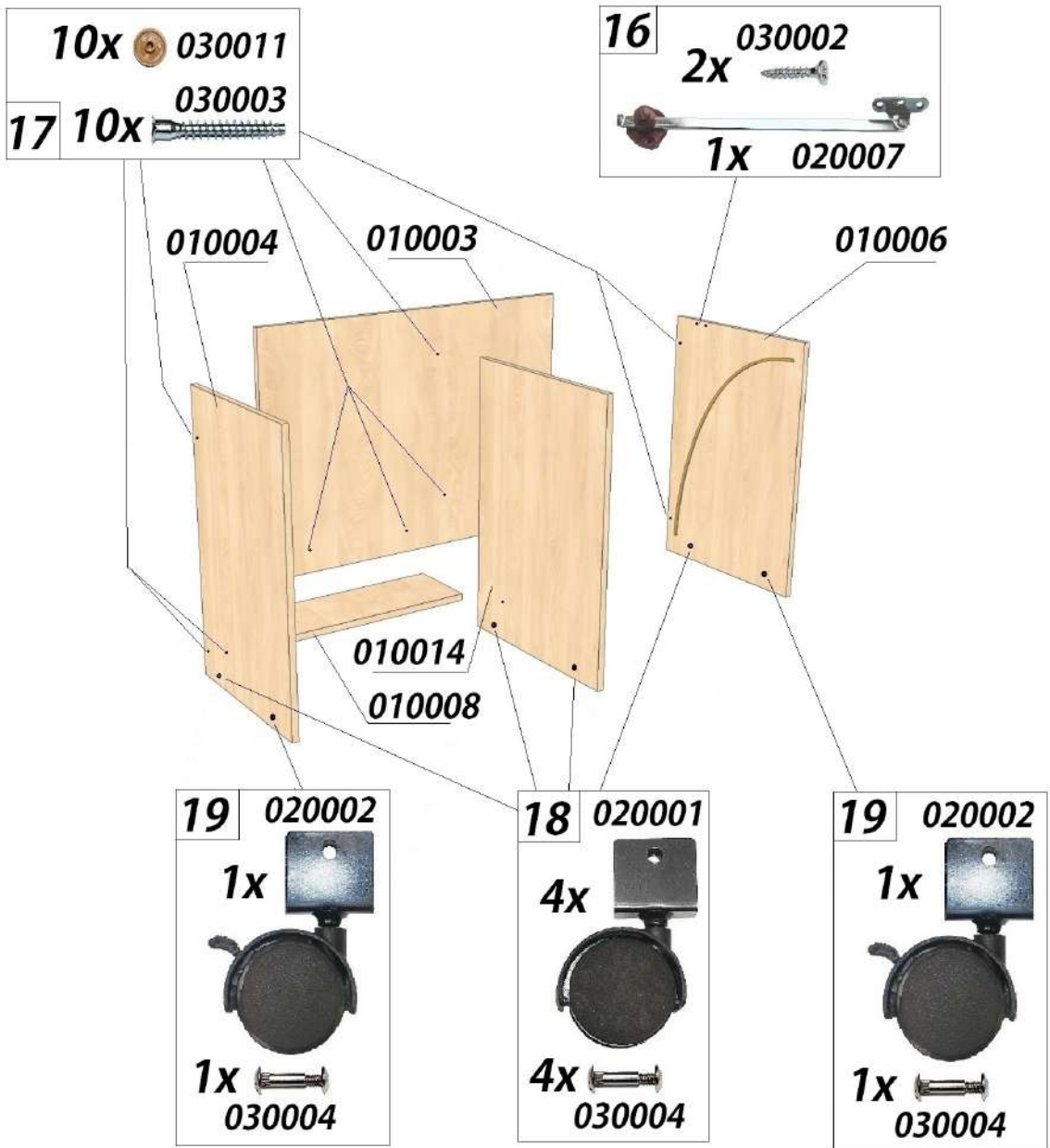







**030002**  
4x 



**020008**  
1x 





**23**

**22** **030008** **030009**  
2x  2x 



1x **020006** 

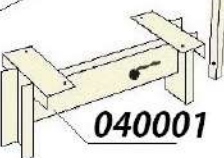



**21**   
1x **020012**  
2x   
**030006**

**24** **020011**  
1x   
4x   
**030002**

**20** **040003**   
**040002**   
**040001**   
2x  6x   
**030007** **030005**

**25**   
1x **020003**   
3x   
**030005**

**26**  
1x **020010**   
22x   
**030001**





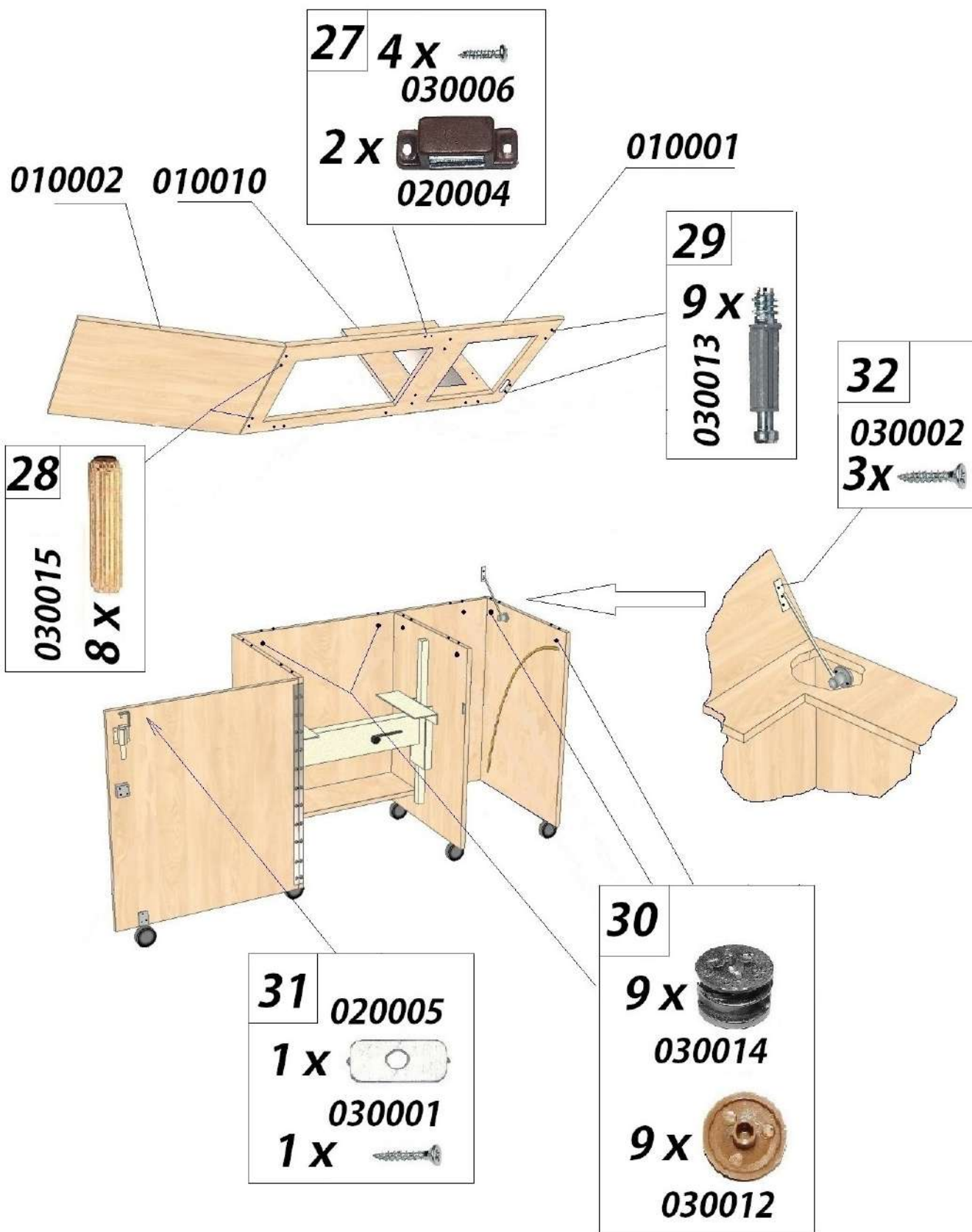

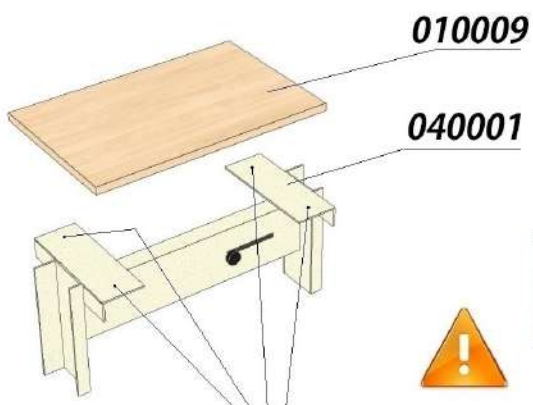
010009

040001

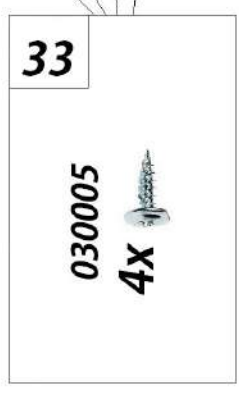
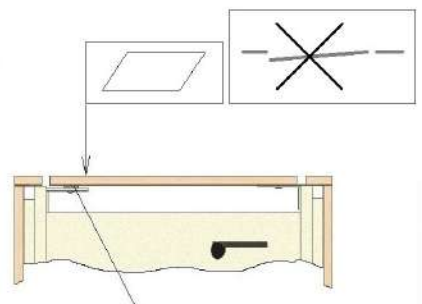

33

030005  
4X



030010

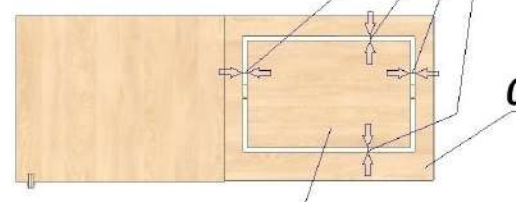

010001

010009

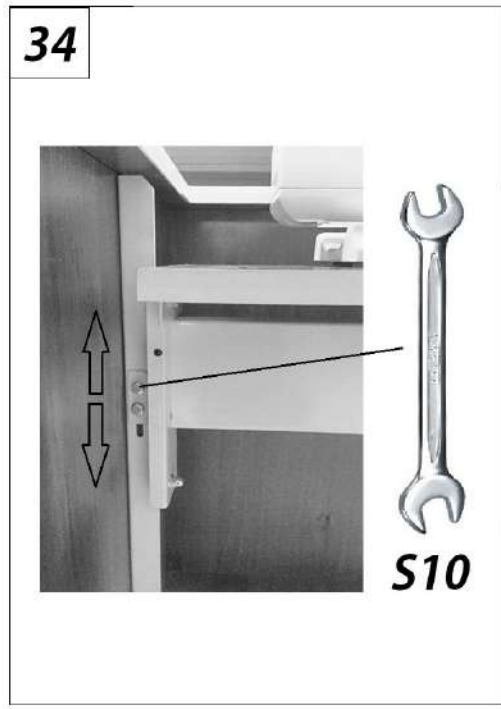

34

S10

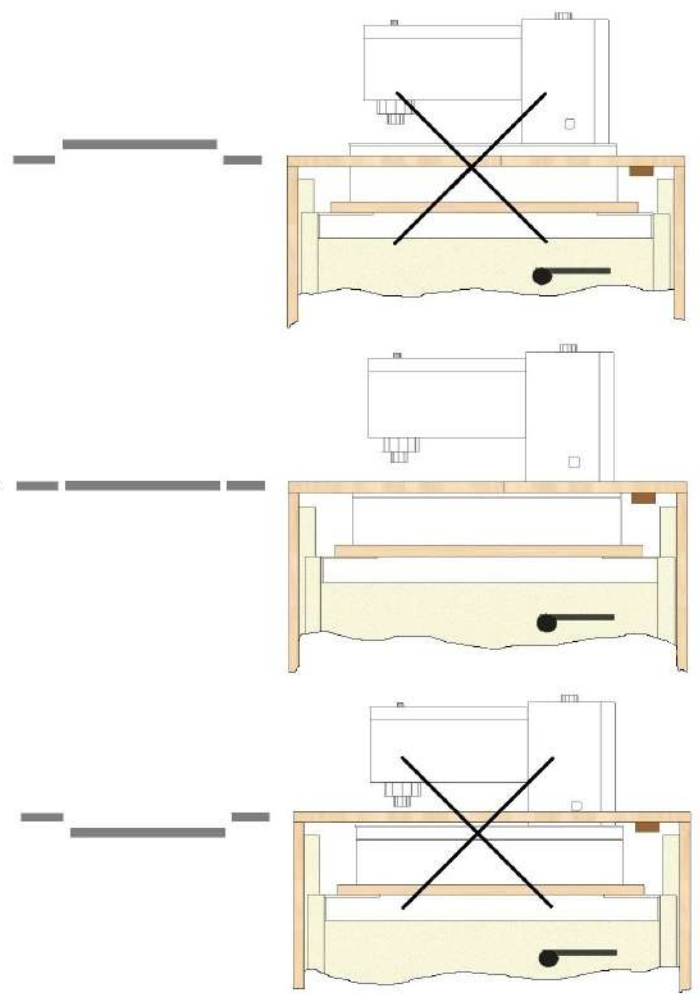
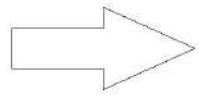

37



1x 050003



2x 050002

4x  030005

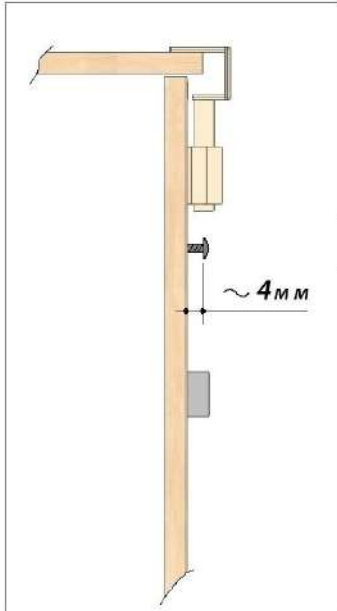

030005 

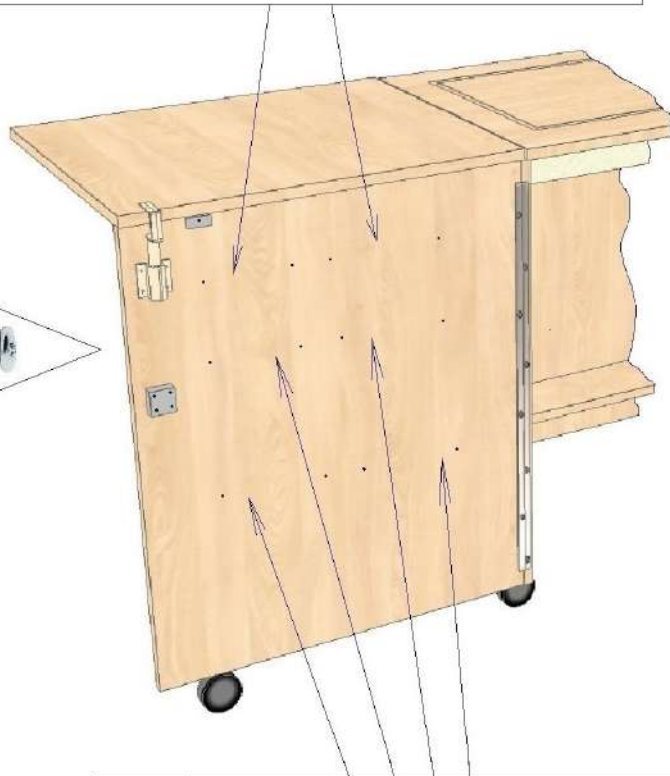

36

4x 050001

8x 



1x 050006

